

IMAGE OPTIONS

CHECK-STAND SHIELD MEASUREMENT WORKSHEET



Check-stand Measurements Worksheet

Countertop Style

Fill in the appropriate countertop dimensions and include a photo.

Store: _____
Phone: _____

5 Fill in store, contact and quantity info

Contact: _____
Email: _____
Check-stand(s): _____ Quantity: _____

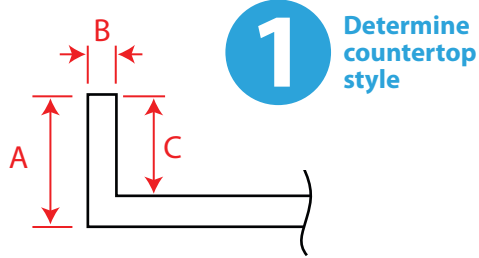

Counter with side-rail

A _____
B _____
C _____

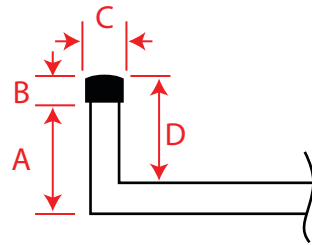

Counter with side-rail and top moulding

A 4"
B 1 1/8"
C 1"
D 3"

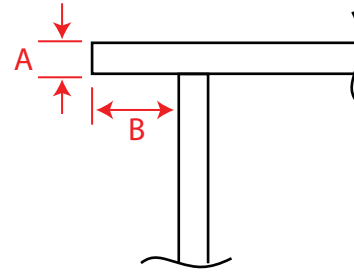

Counter with overhang

A _____
B _____

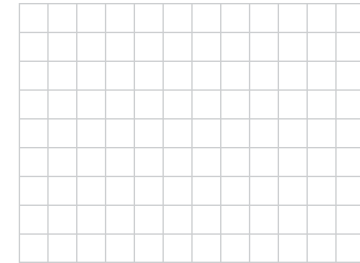

Other

A _____
B _____
C _____
D _____

2 Fill in your measurements

Openings for Obstructions and Transactions

Sketch any obstructions and/or the desired transaction opening sizes and include dimensions. Use a separate form for each unique counter.

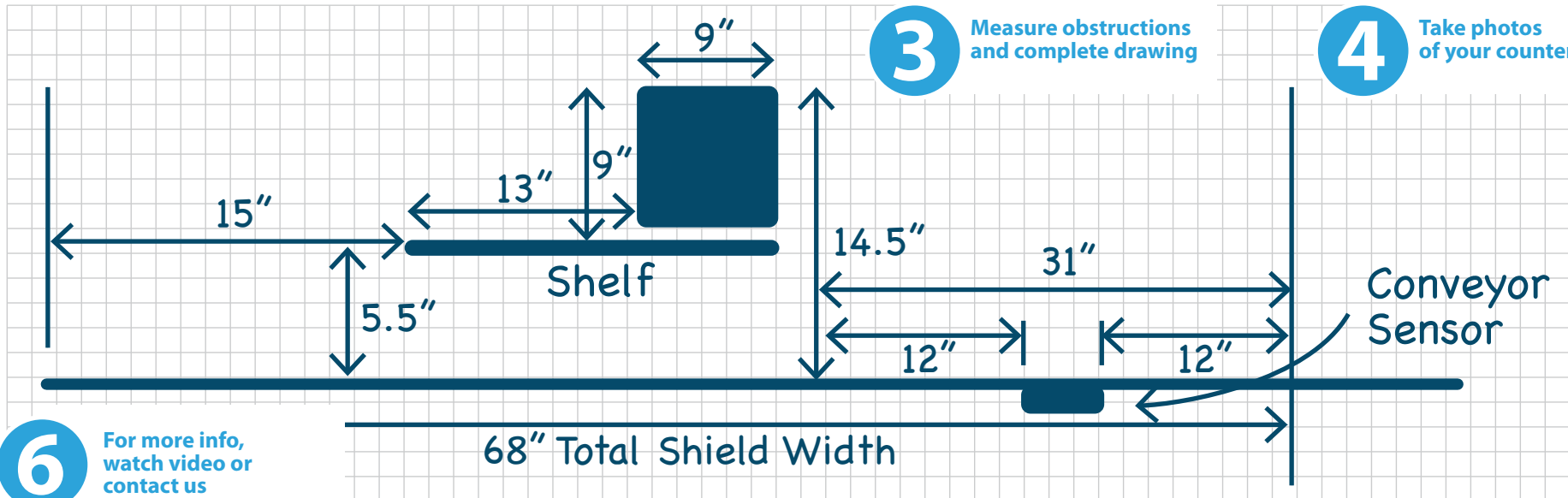

Check-stand Measurements Worksheet

Store: _____

Phone: _____

Contact: _____

Email: _____

Check-stand(s): _____ Quantity: _____

Countertop Style

Fill in the appropriate countertop dimensions and include a photo.

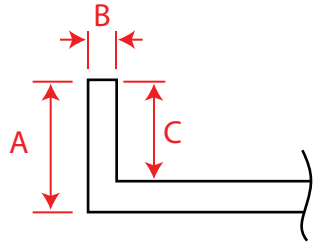

Counter with side-rail

A _____

B _____

C _____

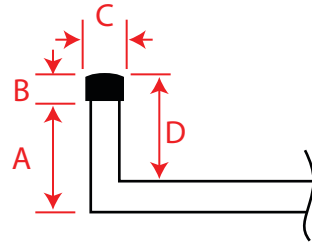

Counter with side-rail and top moulding

A _____

B _____

C _____

D _____

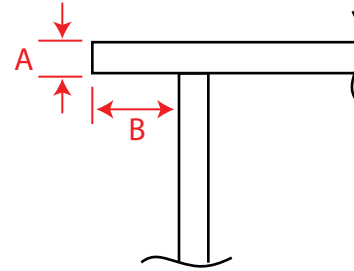

Counter with overhang

A _____

B _____

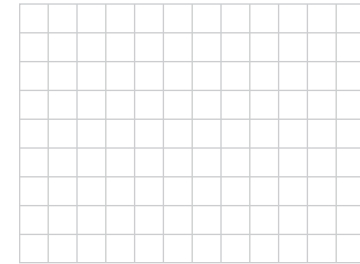

Other

A _____

B _____

C _____

D _____

Openings for Obstructions and Transactions

Sketch any obstructions and/or the desired transaction opening sizes and include dimensions. Use a separate form for each unique counter.

